

P2000L-xxN1.P2000M-xxN1 High Power LED

Introduction

The P2000L-xxN1, P2000M-xxN1 from from SemiLEDs brings industry leading technology to the solid state lighting market with its high quality and performance. Use of state of the art silicone packaging guarantees a long lifetime and high levels of efficacy. P2000 series are reflow solderable and the light output decay is less than 10% under crucial test conditions (700mA, ambient 85°C and 85%RH).



Because of a special design allowing it to fit secondary optics and a capability to easily get uniform light with small size optics, the P2000-series is suitable for a wide variety of lighting applications.

The special phosphor technology used in warm white P2000-series give them very good color stability under high temperature conditions. The typical CCT change is less than 50K when the junction temperature reaches 100°C.

Table of Contents

Characteristics	1
Mechanical Dimensions	3
Recommended Solder Pad Design	4
Relative Spectral Power Distribution	5
Typical Spatial Radiation Pattern	6
Typical Forward L-I Characteristics	7
Typical Forward I-V Characteristics	8
Typical L-Tj Characteristics	9
Recommended Soldering Profile	10
Thermal Design	11
Packing Information	12

RoHS Compliant

Characteristics

Absolute Maximum Ratings (T_j = 25°C)

Parameter	Rating
	White
DC Forward Current (mA)	700 mA
LED Junction Temperature	150°C (White / Royal Blue / Blue / Green)
LED Junction Temperature	125°C (Red / Amber / Super Red)
LED Operating Temperature	-40°C ~ 110°C
Storage Temperature	-40°C ~ 125°C
Soldering Temperature	Max. 260°C / Max. 10sec. (JEDEC 020c)
ESD Sensitivity	2,000 V HBM (JESD-22A-114-B)
Reverse Voltage	Not designed to be driven in reverse bias (VR ≤ 5V)
Preconditioning	Acc. to JEDEC Level 2

General Characteristics at 350mA (T_j=25°C)

Part number	Color	Dominant Wavelength λ _d Peak Wavelength λ _p * Correlated Color Temperature, CCT		2θ _{1/2}	Temperature Coefficient of V _f (mV/°C)	Thermal Resistance Junction to Pad (°C/W)
		Min	Max			
P2000L-C0N1-A1J11H	Cool White	4750K	6000K	145	-2~-4	10
P2000L-CAN1-A1J11H	PC Amber	2200K	2600K	132	-2~-4	10
P2000M-RNN1-E1H11N	Red	620	635	140	-2~-4	10
P2000M-SNN1-E1H11N	Super Red	650*	670*	140	-2~-4	10
P2000M-ANN1-E1H11N	Amber	580	600	140	-2~-4	10
P2000M-GNN1-A1J11N	Green	520	535	140	-2~-4	10
P2000M-BNN1-A1J11N	Blue	460	470	140	-2~-4	10
P2000M-DNN1-A1J11N	Royal Blue	440*	460*	140	-2~-4	10

Notes:

1. The CCT is measured with an accuracy of ±200K
2. SemiLEDs maintains a tolerance of ±2 on CRI measurements.
Typical CRI for Cool White (4750 K – 10,000 K CCT) is 70.

Luminous Flux and Forward Voltage (Tj=25°C)

Part number	Color	Performance at Test Current (350mA)				Performance at 700mA
		Group	Minimum Luminous Flux (lm) *(mW)	VF		Typical Luminous Flux (lm) *(mW)
				Min	Max	
P2000L-CO11 -A1J11H	Cool White	PU3	100	2.8	3.8	170
		PVA	110	2.8	3.8	185
		PVB	120	2.8	3.8	200
		PVC	130	2.8	3.8	220
		PVD	140	2.8	3.8	235
P2000L-CAN1 -A1J11H	PC Amber	PU3	100	2.8	3.8	170
		PVA	110	2.8	3.8	185
		PVB	120	2.8	3.8	200
		PVC	130	2.8	3.8	220

Part number	Color	Performance at Test Current (350mA)				Performance at 700mA
		Group	Minimum Luminous Flux (lm) *(mW)	VF		Typical Luminous Flux (lm) *(mW)
				Min	Max	
P2000M-RNN1 -E1H11N	Red	PR2	45	2	3.4	75
		PS1	50	2	3.4	85
		PS2	55	2	3.4	93
		PTA	65	2	3.4	110
P2000M-SNN1- E1H11N	Super Red	PD2	240*	2	3.4	480*
		PD3	280*	2	3.4	560*
		PD4	320*	2	3.4	640*
		PD5	360*	2	3.4	720*
P2000M-ANN1 -E1H11N	Amber	PR2	45	2	3.4	75
		PS1	50	2	3.4	85
		PS2	55	2	3.4	93
		PTA	65	2	3.4	110
P2000M-GNN1 -A1J11N	Green	PTA	65	2.8	3.8	110
		PUA	80	2.8	3.8	135
		PU2	90	2.8	3.8	150
		PU3	100	2.8	3.8	170

Part number	Color	Performance at Test Current (350mA)			Performance at 700mA	
		Group	Minimum Luminous Flux (lm) *(mW)	VF		Typical Luminous Flux (lm) *(mW)
P2000M-BNN1 -A1J11N	Blue	PN0	18	2.8	3.8	30
		PP1	22	2.8	3.8	37
		PP2	26	2.8	3.8	45
		PQ1	30	2.8	3.8	51
P2000M-DNN1 -A1J11N	Royal Blue	PE2	440*	2.8	3.8	745*
		PE3	480*	2.8	3.8	815*
		PE4	520*	2.8	3.8	880*

Note:

1. Luminous flux is measured with an accuracy of $\pm 10\%$
2. The forward voltage is measured with an accuracy of $\pm 0.1V$

Mechanical Dimensions

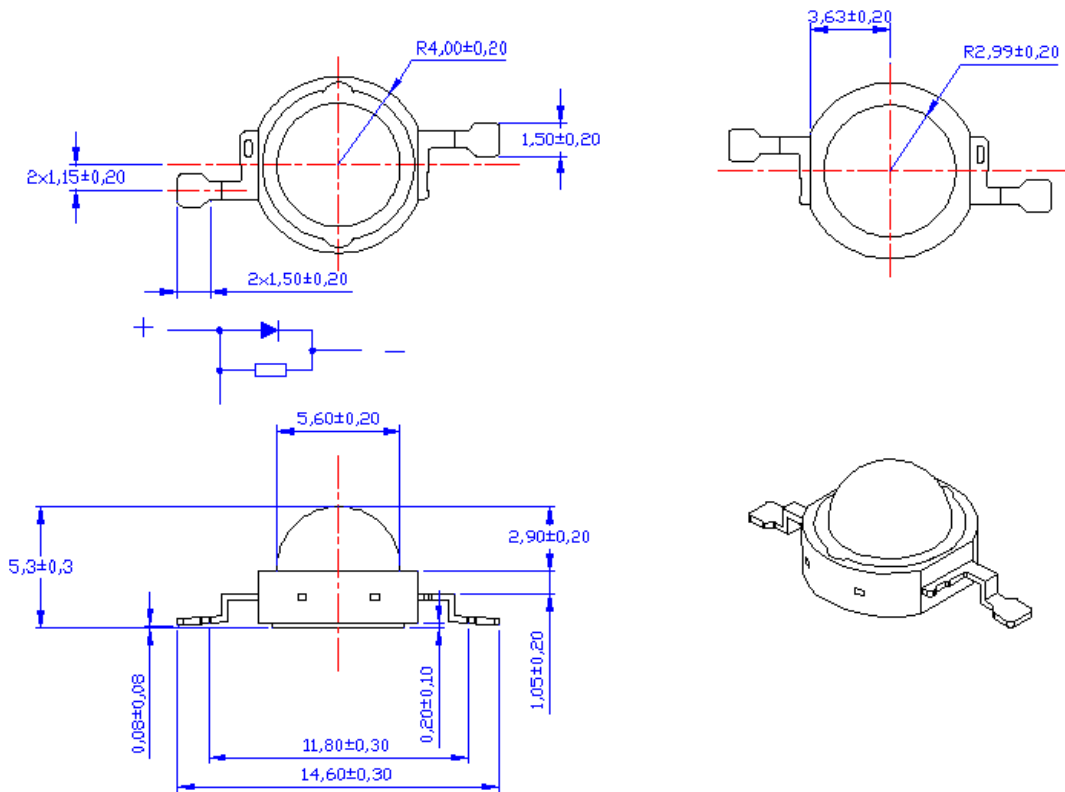

Notes:

1. Drawing is not to scale
2. All dimensions are in millimeter

Recommended Solder Pad Design

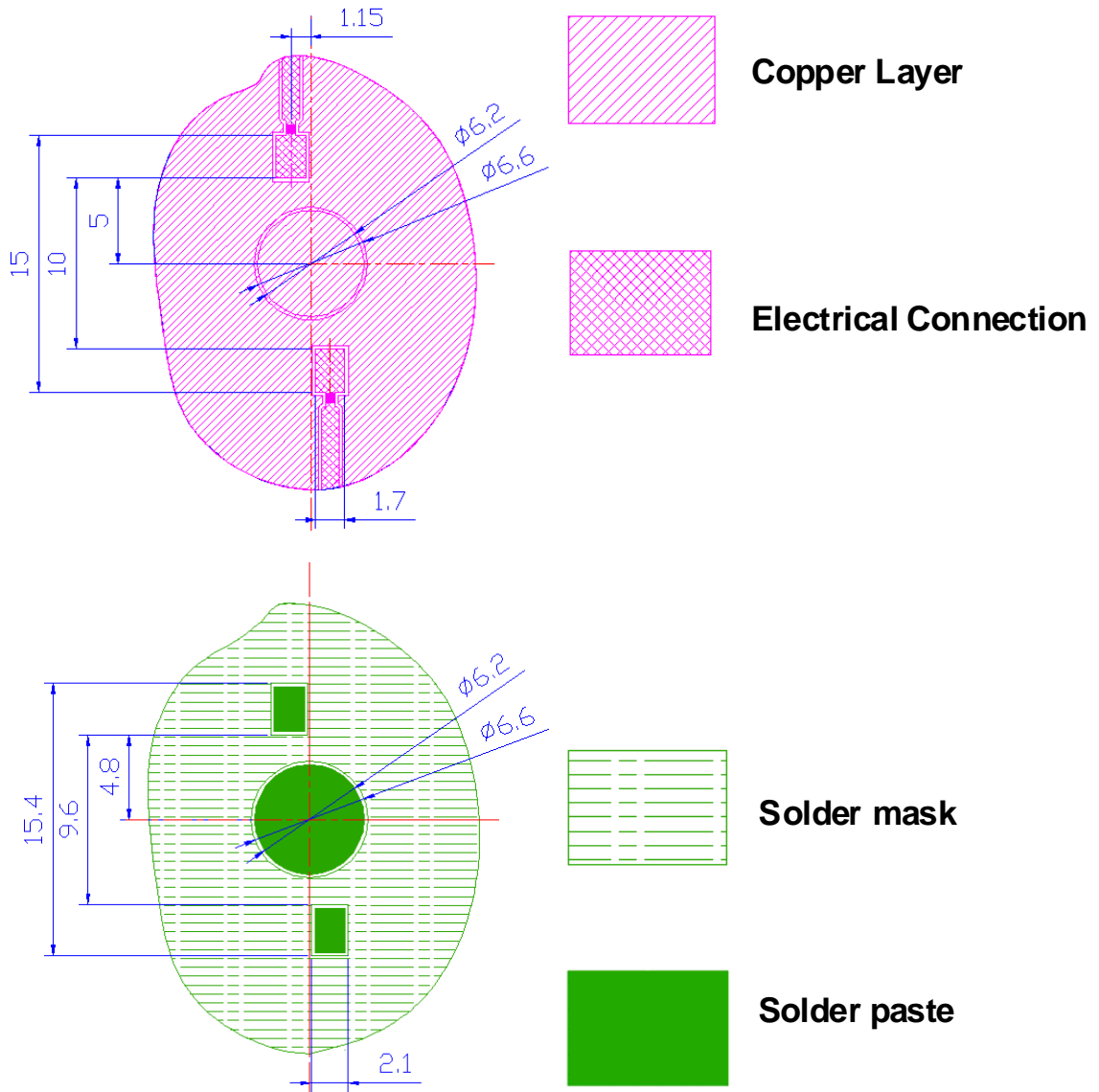

Notes:

1. Drawing is not to scale
2. All dimensions are in millimeter

Relative Spectral Power Distribution, Ta=25 °C

White light

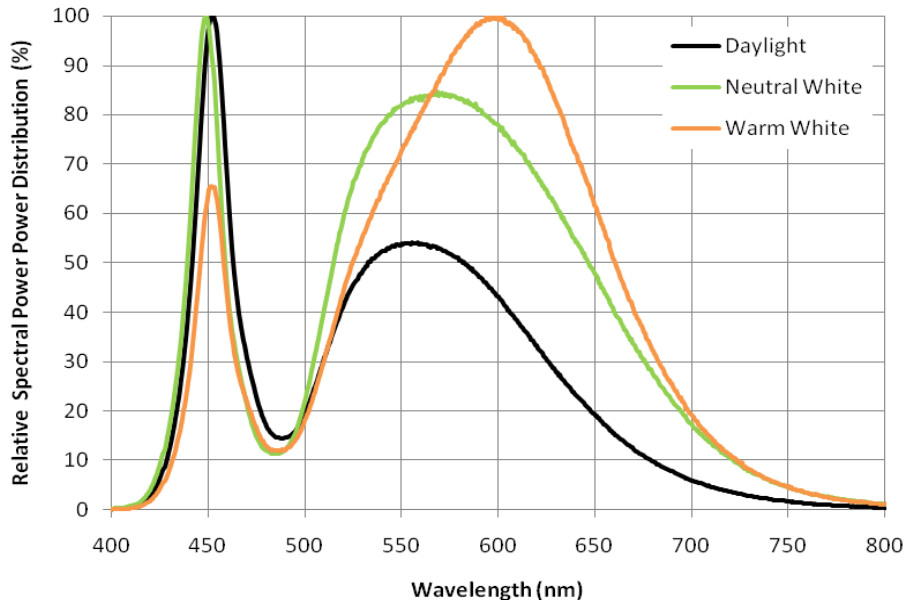

Royal Blue / Blue / Green / Amber / Red

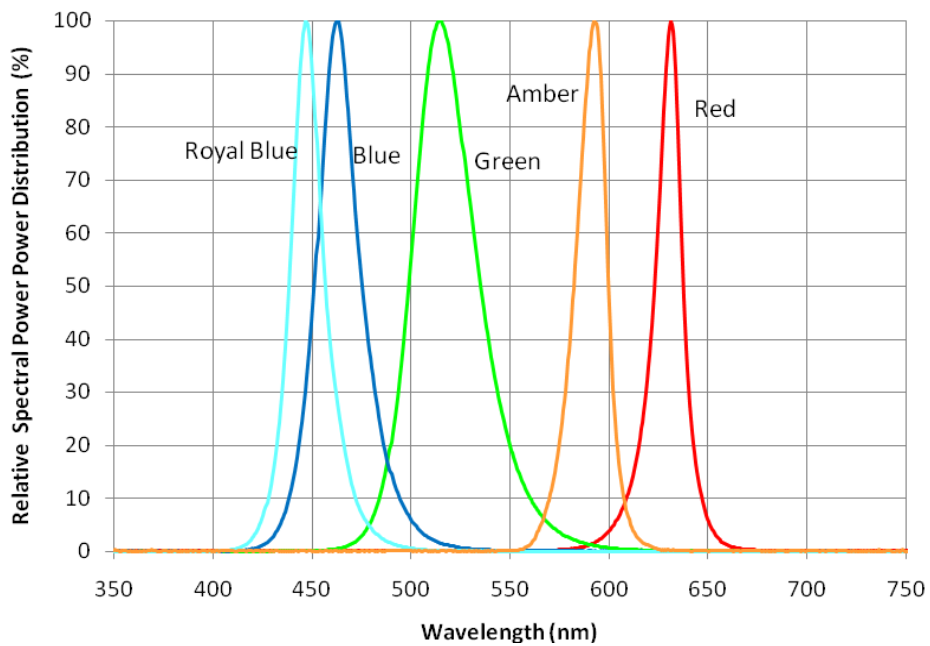

Typical Spatial Radiation Pattern

P2000L-C0N1-A1J11H, Cool White

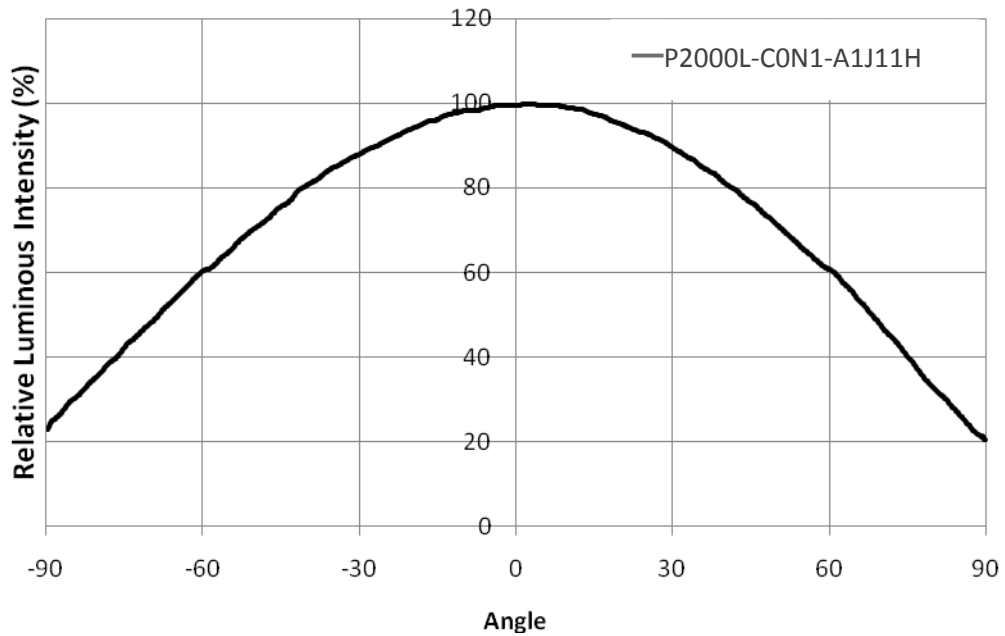

P2000M-R,A / P2000M-G/ P2000M-B/ P2000M-D ,Pure Color series

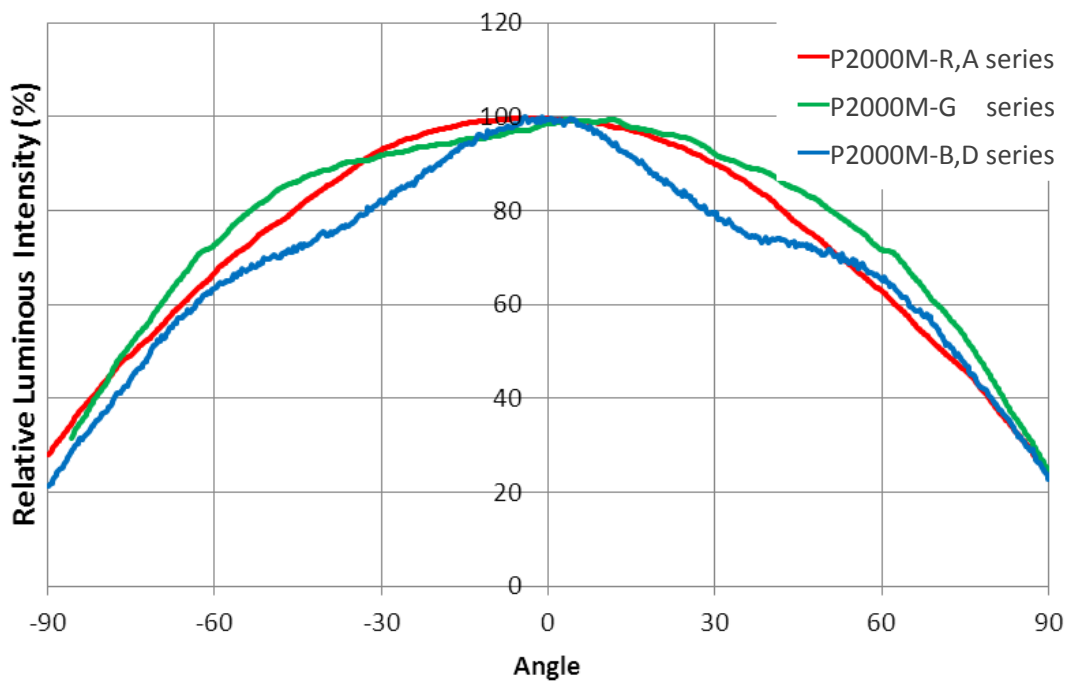

Typical Forward L-I Characteristics, T_j=25°C

White Series/ Green / Blue / Royal Blue

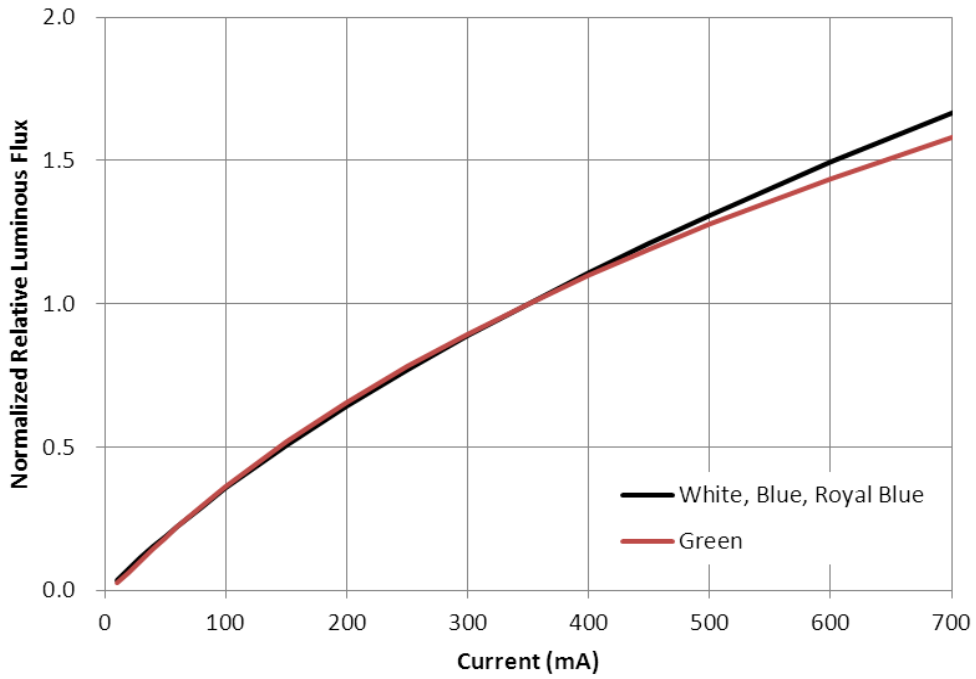

Amber / Red

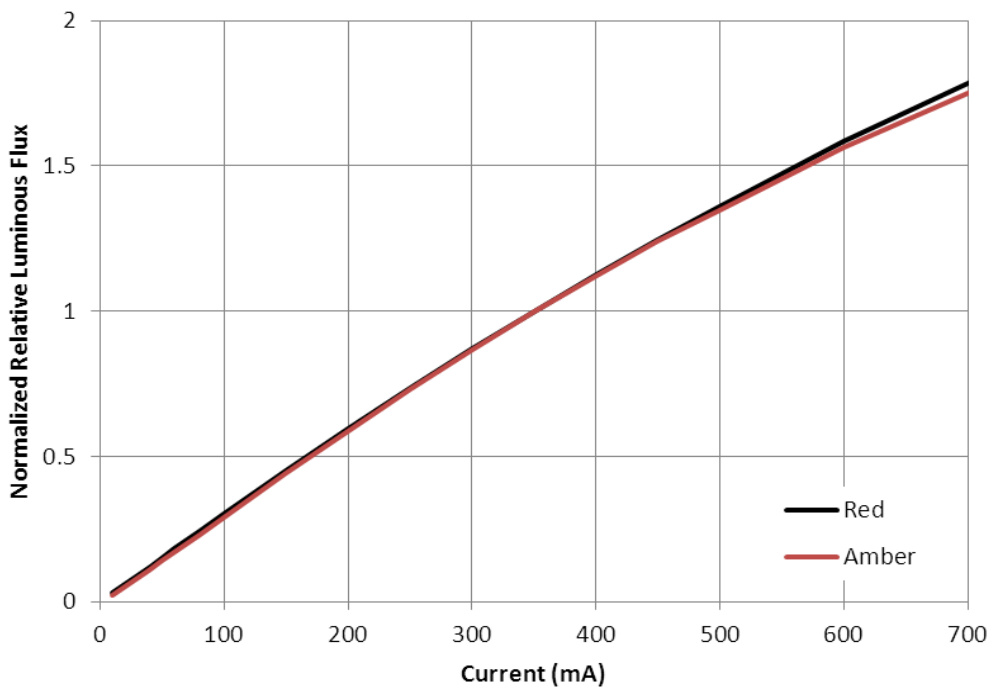

Typical Forward I-V Characteristics, T_j=25°C

White series/ Green / Blue / Royal Blue

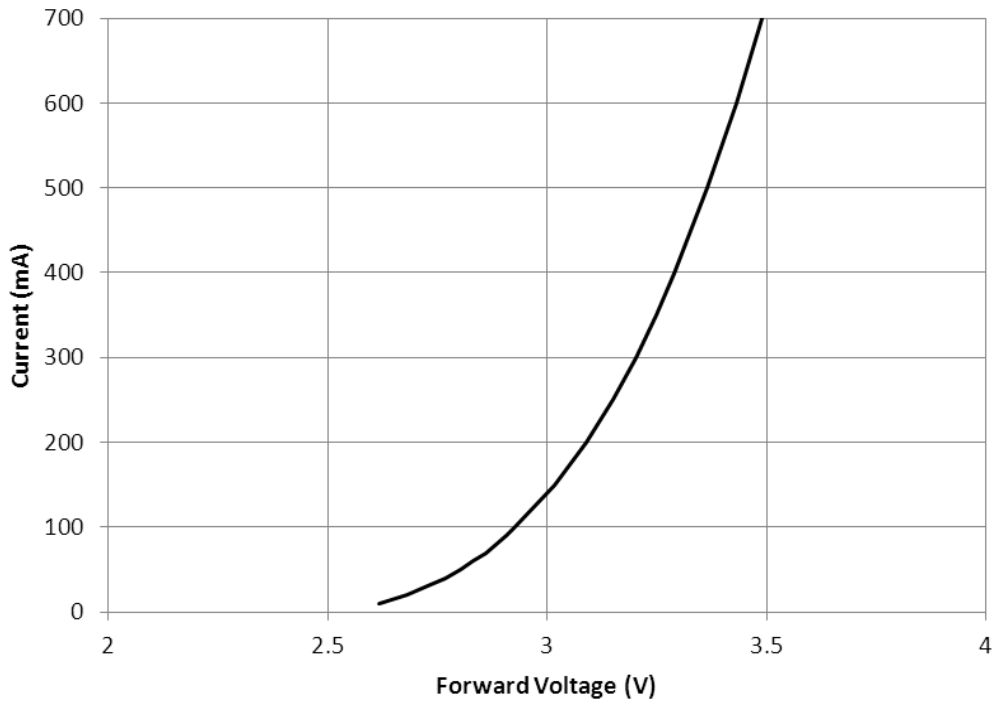

Amber / Red

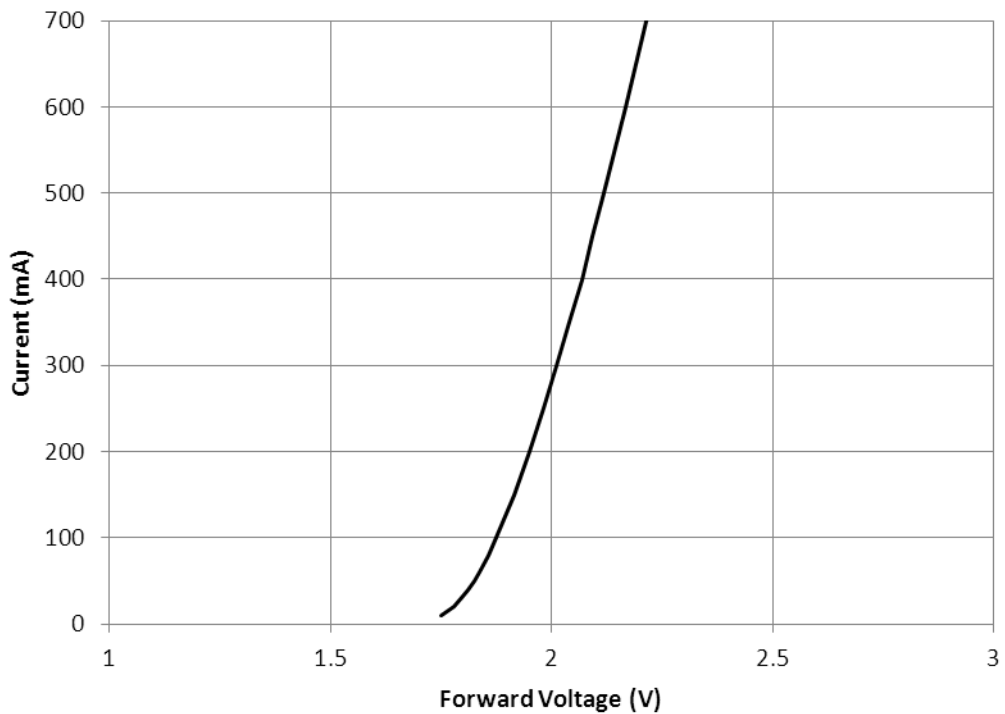

Typical Light Output vs. Tj Characteristics

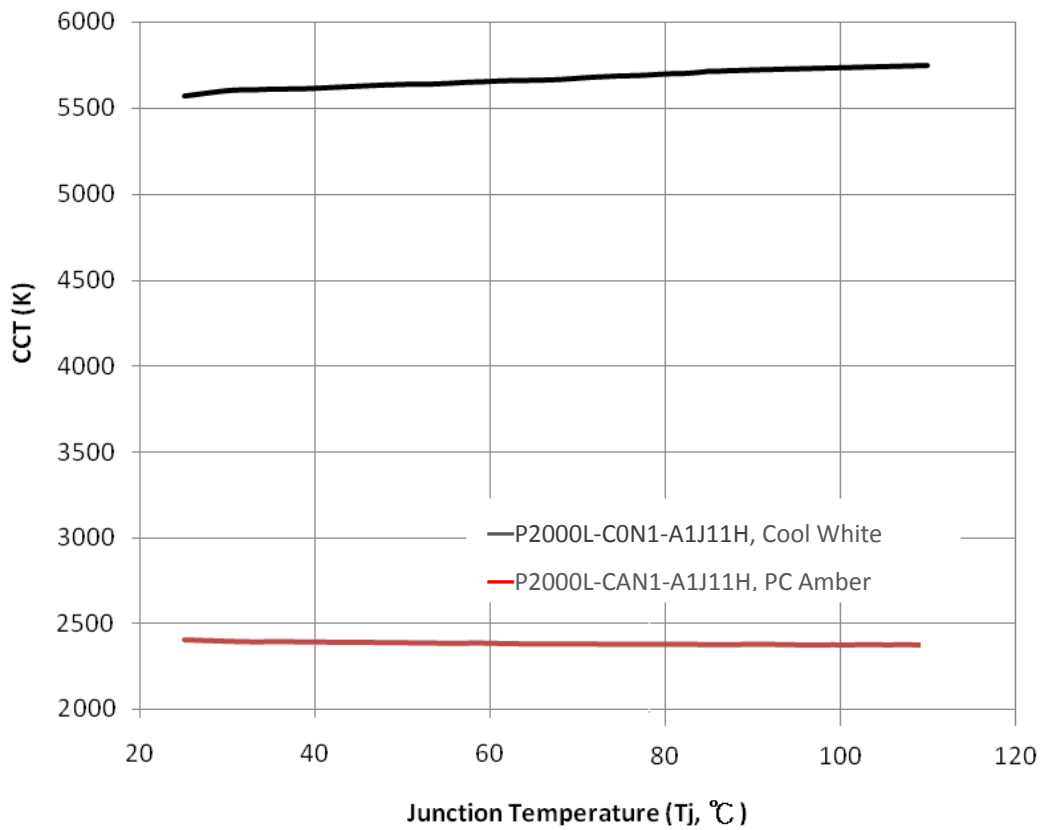
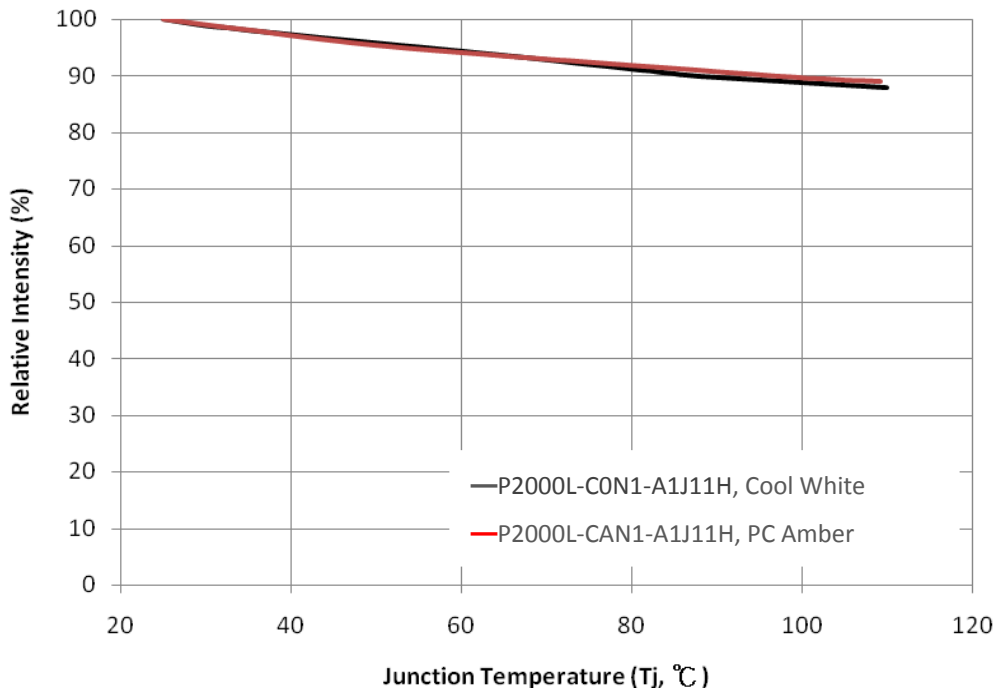

Recommended Soldering Profile

LEDs should be soldered using the parameter listed below. As a general guideline, users are suggested to follow the recommended soldering profile provided by the manufacturer of the solder paste. Although the recommended soldering conditions are specified in the list, reflow soldering at the lowest possible temperature is advised for the LEDs.

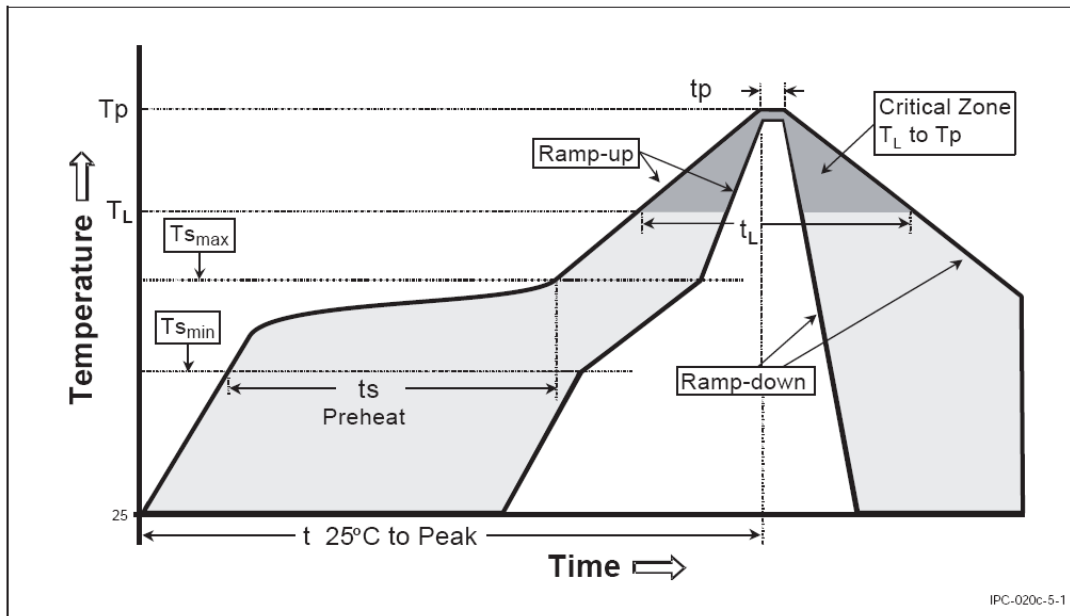

Profile Feature	Sn-Pb Eutectic Assembly	Pb-Free Assembly
Average Ramp-up Rate (T _{smax} to T _p)	3°C/second max.	3°C/second max.
Preheat		
- Temperature Min(T _{smin})	100°C	150°C
- Temperature Max(T _{smax})	150°C	200°C
- Time(ts _{min} to ts _{max})	60-120 seconds	60-180 seconds
Time maintained above:		
- Temperature(T _L)	183°C	217°C
- Time(t _L)	60-150 seconds	60-150 seconds
Peak/classification Temperature(T _p)	215°C	240°C
Time within 5°C of actual Peak Temperature(tp)	10-30 seconds	20-40 seconds
Ramp-Down Rate	6°C/second max.	6°C/second max.
Time 25°C to Peak Temperature	6 minutes max.	8 minutes max.

Thermal Design

Thermal design of the end product is important. The thermal resistance between the junction and the solder point ($R_{\theta J-L}$) is $10^{\circ}\text{C}/\text{W}$, and the end product is designed to minimize the thermal resistance from the solder point to ambient in order to optimize the emitter life and optical characteristics. The maximum operation current is determined by the plot of Allowable Forward Current vs. Ambient Temperature.

White series/ Green / Blue / Royal Blue

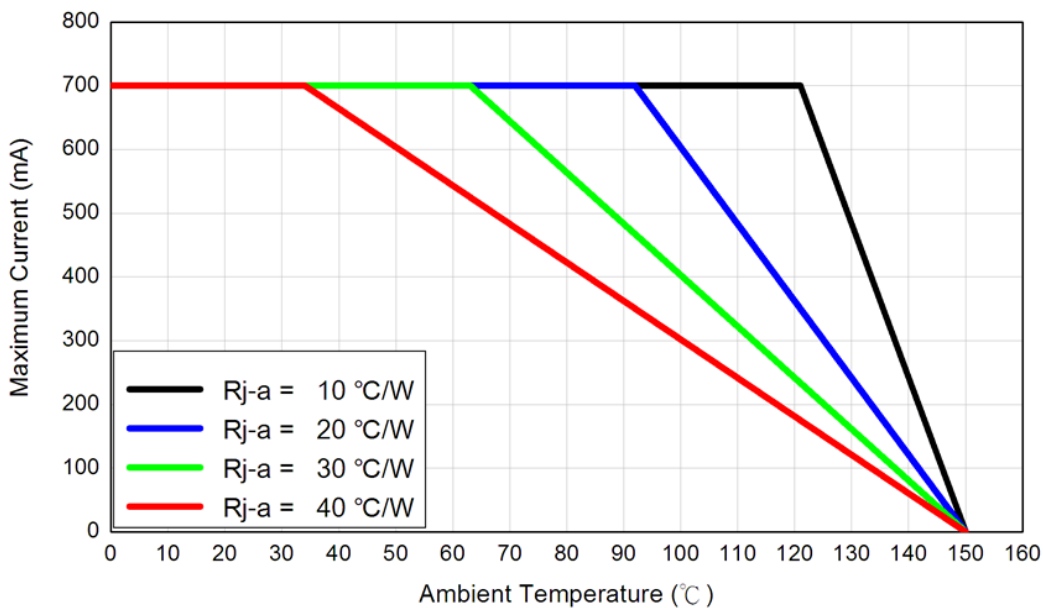

Amber / Red

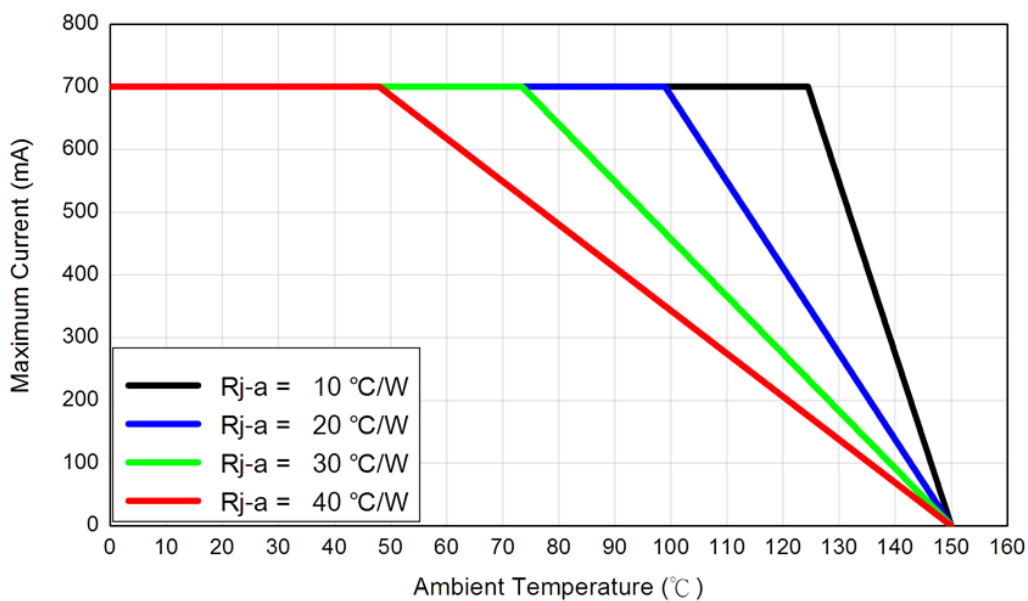

The junction temperature can be correlated to the thermal resistance between the junction and ambient (Rja) by the following equation.

$$T_j = T_a + R_{ja} * W$$

Tj: LED junction temperature

Ta: Ambient temperature

Rja: Thermal resistance between the junction and ambient

W: Input power ($I_f * V_f$)

Shipping Package Information

Tube

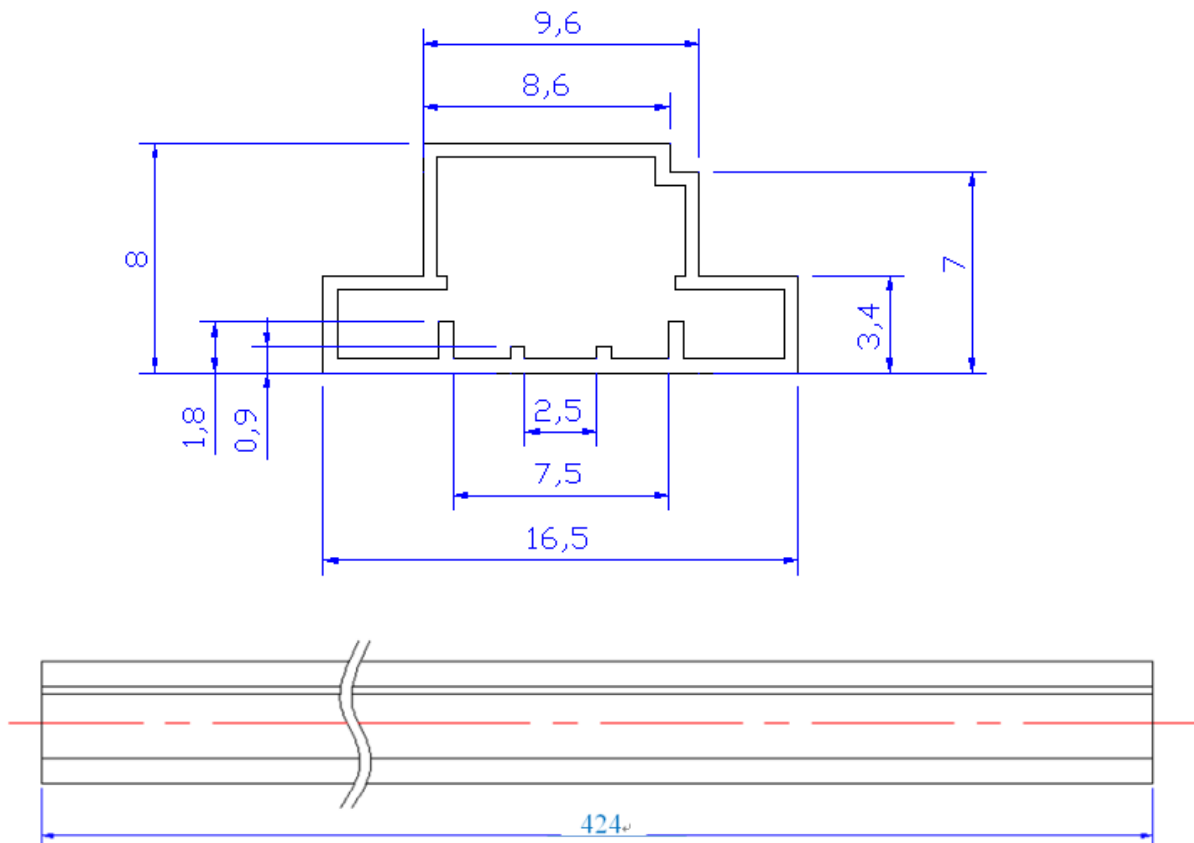

All dimensions are in millimeter

	Dimensions (L*W*H)	Emitter Quantity
Tube	424*16.7*10.0 mm	50 EA

About Us

SemiLEDs is an innovative manufacturer of chip-level and packaged LEDs that enable today's advanced solid state lighting solutions. Fully ISO9001 certified, with state of the art fabrication facilities in Hsinchu Science Park, Taiwan, the company employs patented and proprietary technologies that deliver high performance with increased color stability and lumen maintenance. SemiLEDs visible- and ultraviolet-LEDs are found in a wide variety of general lighting applications, including street lights and commercial, industrial and residential architectural lighting, along with specialty industrial applications such as UV curing, medical/cosmetic, counterfeit detection, and horticulture.

SemiLEDs is a publicly traded company on NASDAQ Global Select Market (stock symbol "LEDS"). For investor information, please contact us at investors@semileds.com.

For further company or product information, please visit us at www.semileds.com or please contact sales@semileds.com.



www.semileds.com

ASIA PACIFIC

3F, No. 11, KeJung Rd.

Chu-Nan Site

Hsinchu Science Park

Chu-Nan 350, Miao-Li County

Taiwan, ROC

Tel: +886-37-586788

Fax: +886-37-582688

sales@semileds.com