

# T9090U-UNL1

## High Power UV LED

### Introduction

The T9090U-UNL1 product is a compact, high quality and reliable 12-chip UV LED. Featuring high radiometric power density and design flexibility - the T9090U-UNL1 spectrum can be tailored to your printer, inkjet, glue adhesive curing, and other general purpose UV applications.

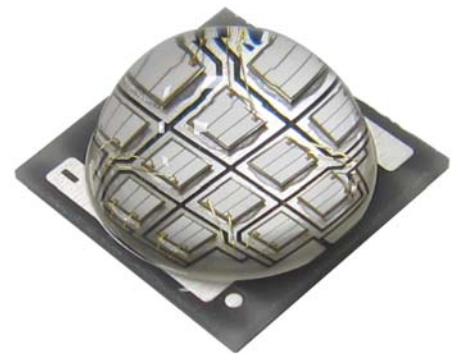

### Table of Contents

Characteristics .....	1
Mechanical Dimensions .....	3
Recommended Solder Pad Design.....	4
Relative Spectral Power Distribution.....	5
Typical Spatial Radiation Pattern .....	5
Typical Forward L-I Characteristics .....	6
Typical Forward I-V Characteristics .....	6
Recommended Soldering Profile .....	7
Thermal Design.....	8
Packing information .....	9

**RoHS Compliant**

## Characteristics

### Absolute Maximum Ratings (T<sub>j</sub> = 25°C)

Parameter	Rating
	UV Series
DC Forward Current (mA) *	700 mA
LED Junction Temperature	150°C
LED Operating Temperature	-40°C ~ 85°C
Storage Temperature	-40°C ~ 125°C
Soldering Temperature	Max. 260°C / Max. 10sec. (JEDEC 020c)
ESD Sensitivity	2,000 V HBM (JESD-22A-114-B)
Reverse Voltage	Not designed to be driven in reverse bias (VR ≤ 5V)
Preconditioning	Acc. to JEDEC Level 2

\* Ambient temperature is well-controlled under 85°C

### General Characteristics at 350mA

Part number	Color	Peak Wavelength λ <sub>p</sub>		2θ <sub>1/2</sub>	Temperature Coefficient of Vf (mV/°C)	Thermal Resistance Junction to Pad
		Min	Max			
T9090U-UNL1-A1GC1H	U40	380	390	140	-12.4	1.9
	U50	390	400	140	-12.4	1.9
	U60	400	410	140	-12.4	1.9
	U70	410	420	140	-12.4	1.9

Notes: The peak/dominant wavelength is measured with an accuracy of ±1nm

The thermal resistance is without including radiometric power.

Radiometric Power and Forward Voltage ( $T_j = 25^\circ\text{C}$ )

Part number	Color	Performance at Test Current (350mA)				Performance at 700mA
		Group	Minimum Radiometric Power (W)	VF		*Calculated Minimum Radiation Power (W)
				Min	Max	
T9090U-UNL1-A1GC1H	U40	NK4	5.5	33.6	44.4	9.9
		NK5	6.0	33.6	44.4	10.8
		NK6	6.5	33.6	44.4	11.7
	U50	NK4	5.5	33.6	44.4	9.9
		NK5	6.0	33.6	44.4	10.8
		NK6	6.5	33.6	44.4	11.7
	U60	NK4	5.5	33.6	44.4	9.9
		NK5	6.0	33.6	44.4	10.8
		NK6	6.5	33.6	44.4	11.7
	U70	NK4	5.5	33.6	44.4	9.9
		NK5	6.0	33.6	44.4	10.8
		NK6	6.5	33.6	44.4	11.7

- Note: 1. Radiometric power is measured with an accuracy of  $\pm 10\%$   
 2. The forward voltage is measured with an accuracy of  $\pm 0.2\text{V}$   
 \* Calculated values are for reference only.

## Mechanical Dimensions

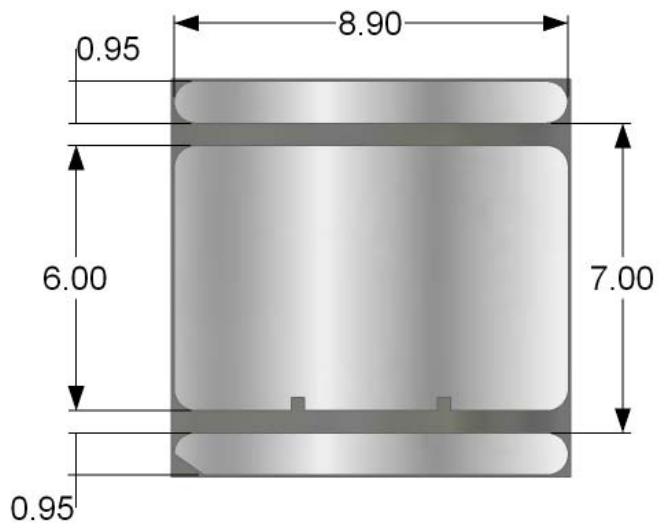
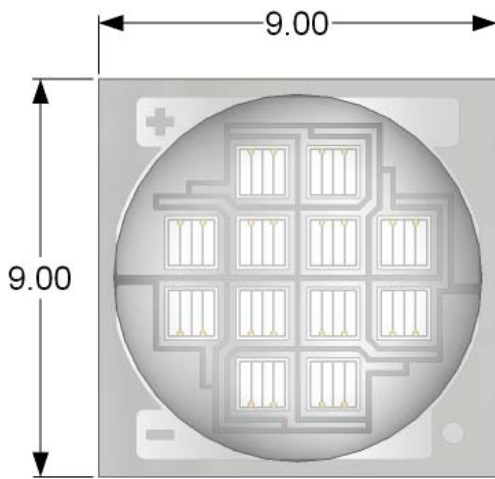
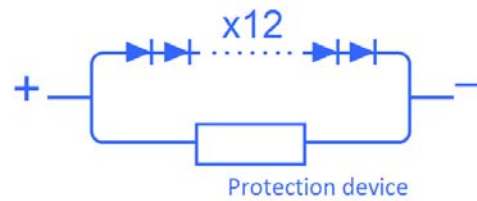
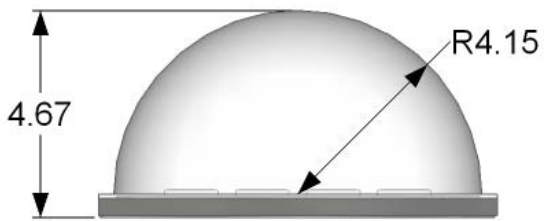
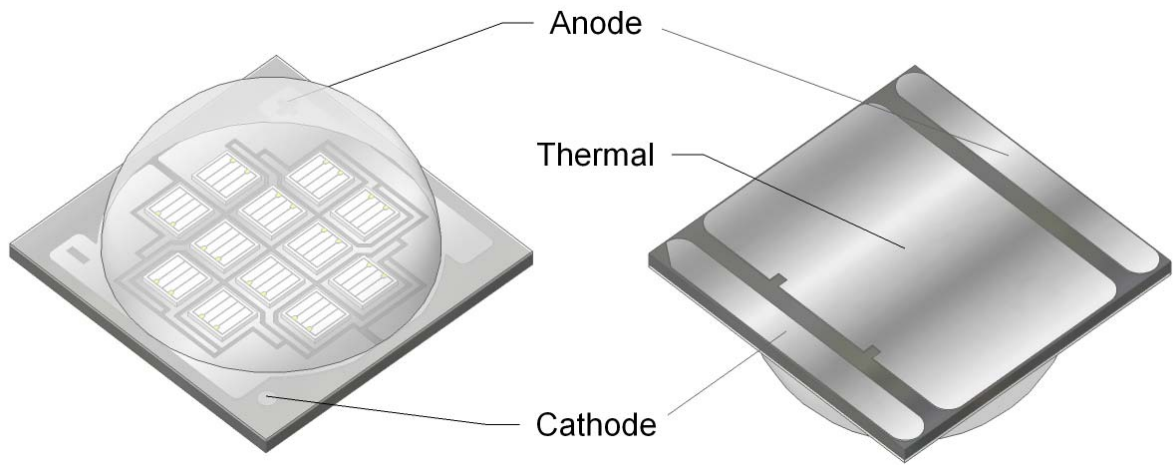

Notes :

1. Drawing is not to scale
2. All dimensions are in millimeter
3. Dimensions are  $\pm 0.13\text{mm}$  unless otherwise indicated

## Recommended Solder Pad Design

### Recommended Soldering Pad Design

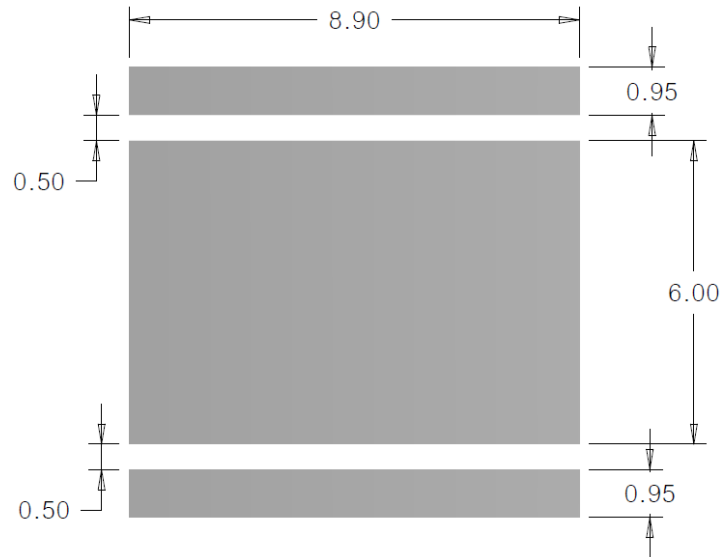

### Recommended Stencil Pattern Design (Marked Area is Opening)

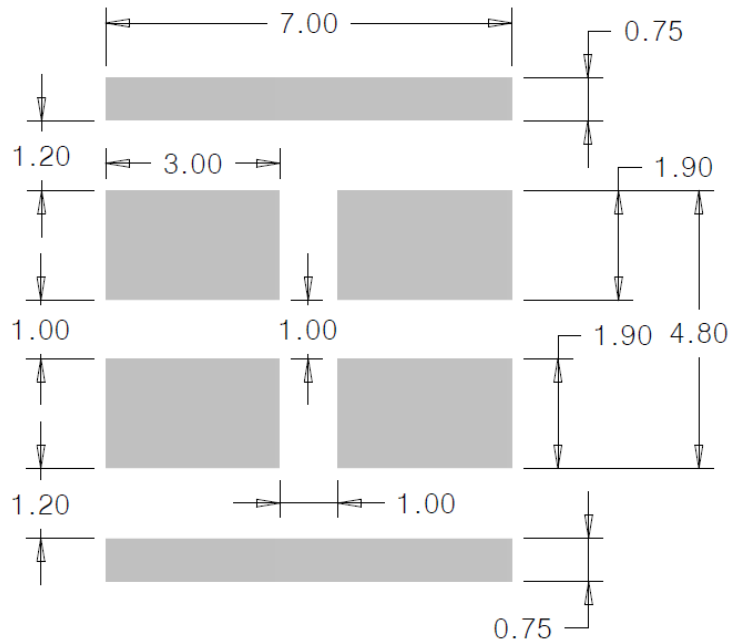

#### Notes :

1. Drawing is not to scale
2. All dimensions are in millimeter

## Relative Spectral Power Distribution, T<sub>j</sub>=25°C

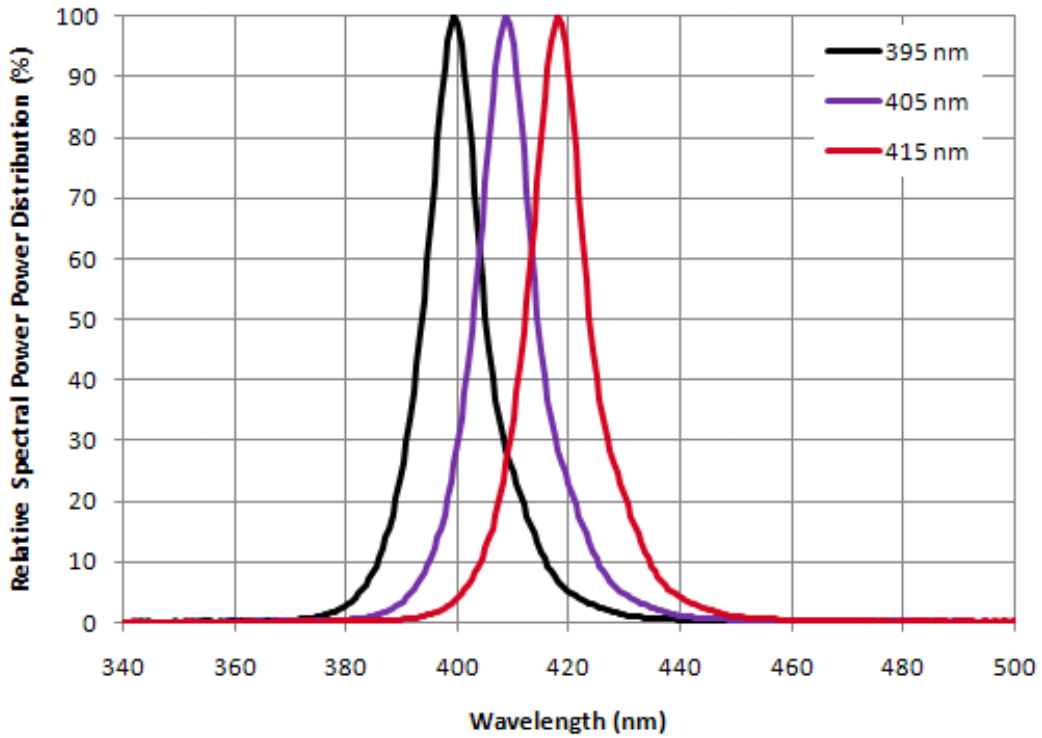

## Typical Spatial Radiation Pattern

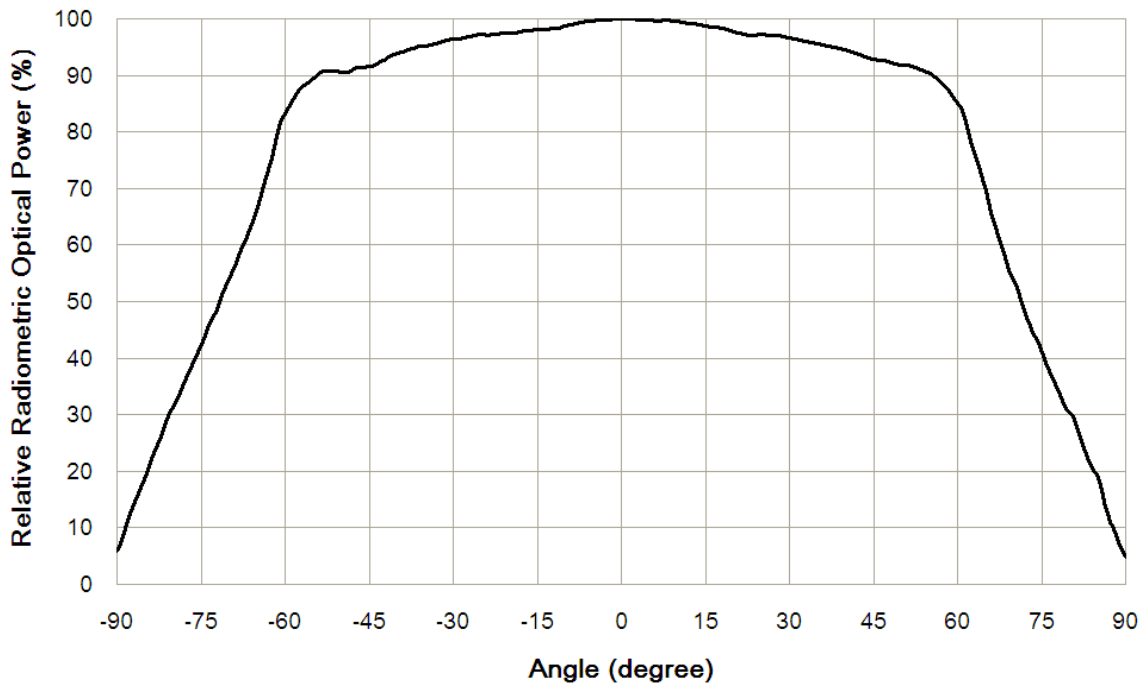

### Typical Forward L-I Characteristics, $T_j=25^\circ\text{C}$

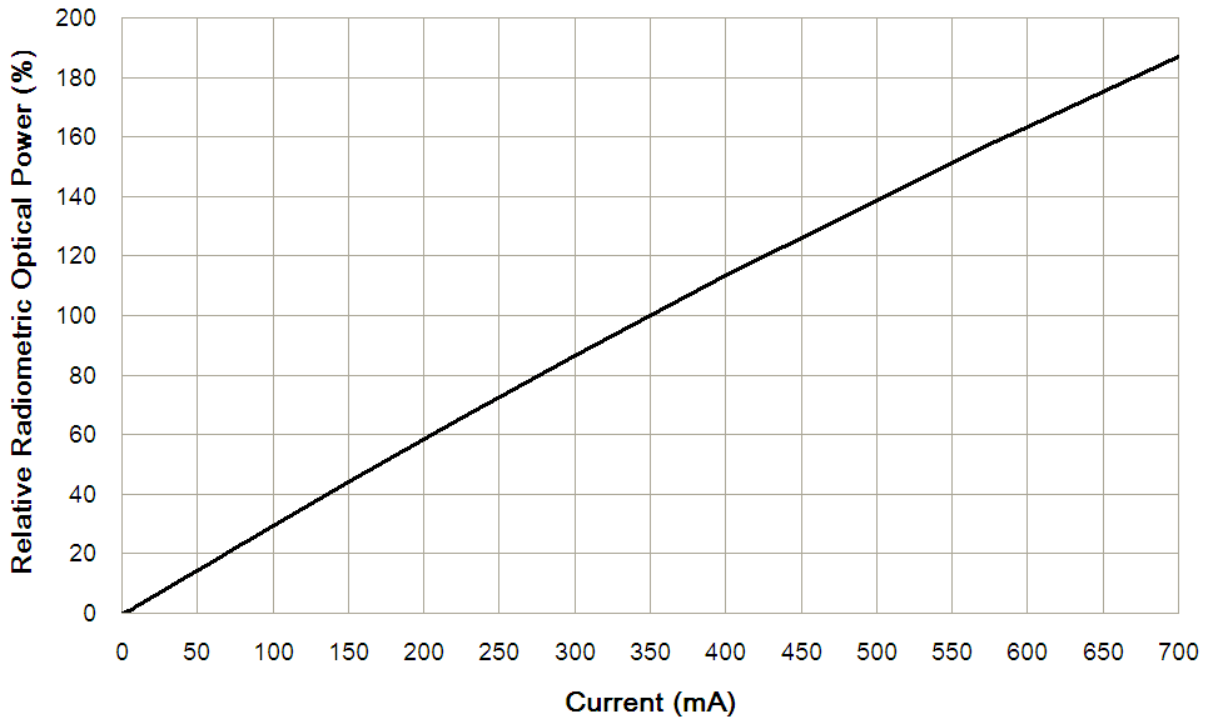

### Typical Forward I-V Characteristics, $T_j=25^\circ\text{C}$

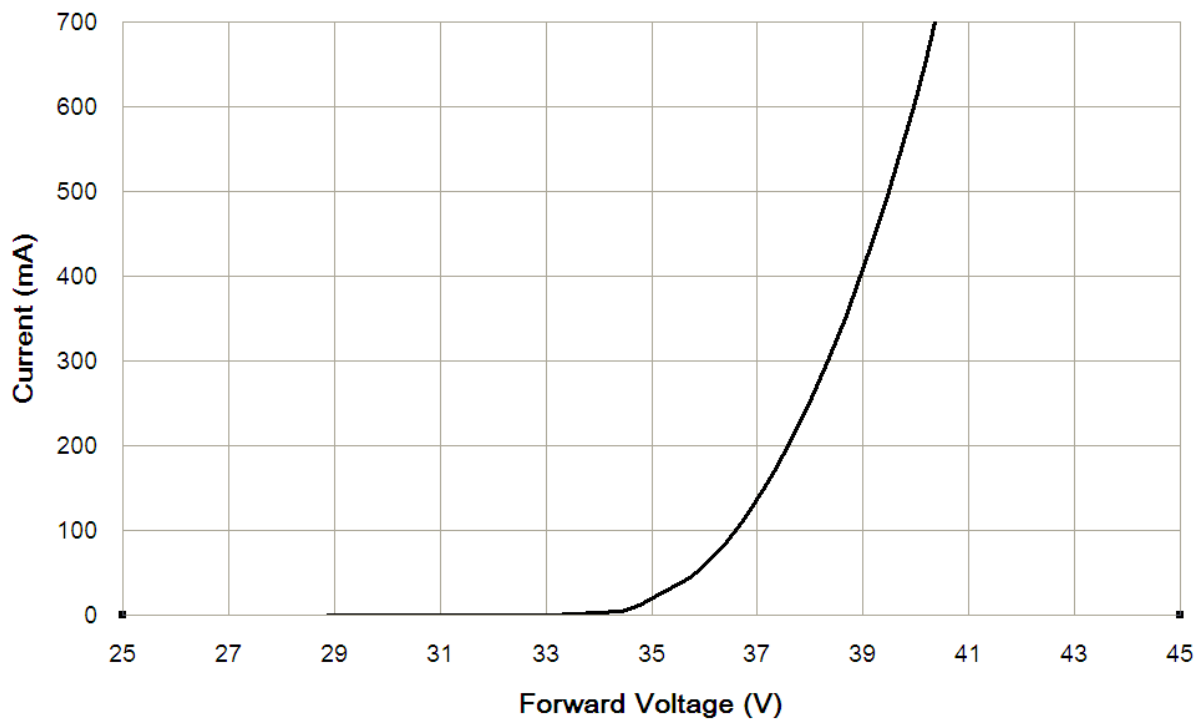

## Recommended Soldering Profile

The LEDs can be soldered using the parameters listed below. As a general guideline, the users are suggested to follow the recommended soldering profile provided by the manufacturer of the solder paste. Although the recommended soldering conditions are specified in the list, reflow soldering at the lowest possible temperature is advised for the LEDs.

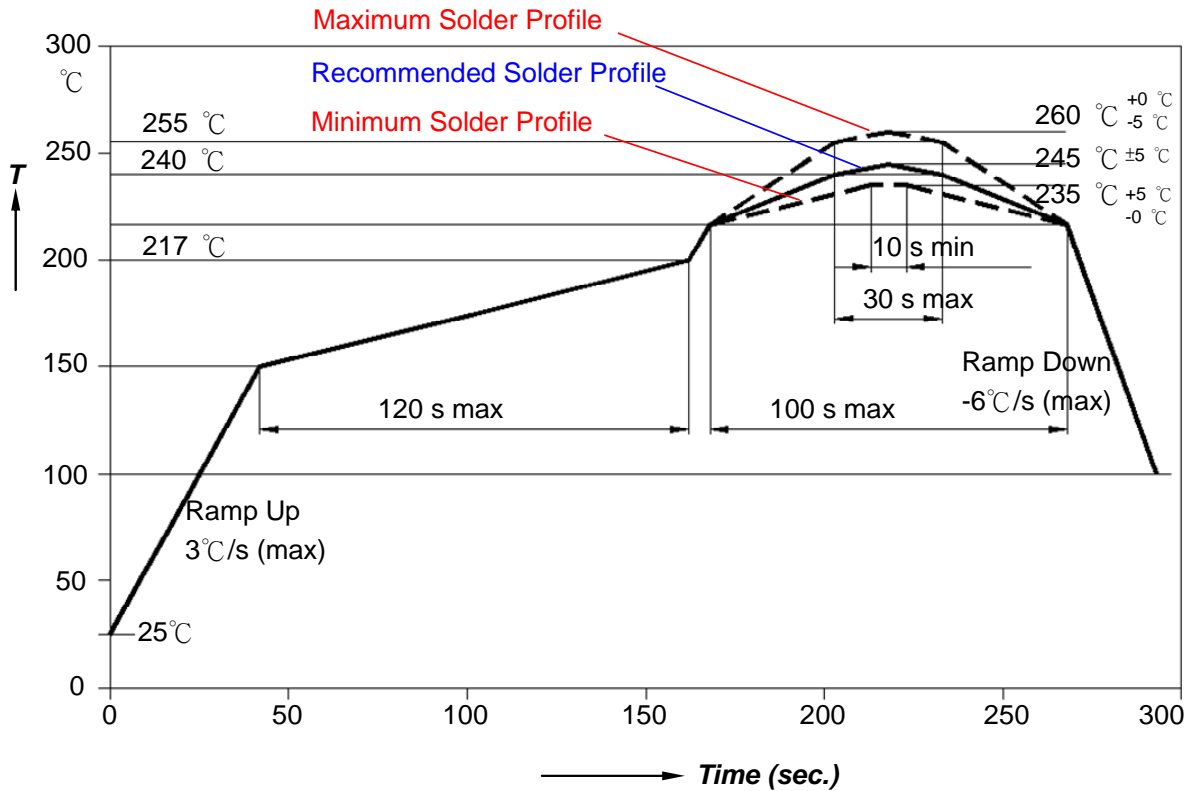

Profile Feature	Sn-Pb Eutectic Assembly	Pb-Free Assembly
Average Ramp-up Rate (T <sub>Smax</sub> to T <sub>p</sub> )	3°C/second max.	3°C/second max.
Preheat		
- Temperature Min(T <sub>Smin</sub> )	100°C	150°C
- Temperature Max(T <sub>Smax</sub> )	150°C	200°C
- Time(t <sub>Smin</sub> to t <sub>Smax</sub> )	60-120 seconds	60-180 seconds
Time maintained above:		
- Temperature(T <sub>L</sub> )	183°C	217°C
- Time(t <sub>L</sub> )	60-150 seconds	60-150 seconds
Peak/classification Temperature(T <sub>p</sub> )	215°C	260°C
Time within 5°C of actual Peak Temperature(tp)	10-30 seconds	20-40 seconds
Ramp-Down Rate	6°C/second max.	6°C/second max.
Time 25°C to Peak Temperature	6 minutes max.	8 minutes max.



## Thermal Design

Thermal design of the end product is important. The thermal resistance between the junction and the solder point ( $R_{\theta_{j-p}}$ ) and the end product should be designed to minimize the thermal resistance from the solder point to ambient in order to optimize the emitter life and optical characteristics. The maximum operation current is determined by the plot of Allowable Forward Current vs. Ambient Temperature.

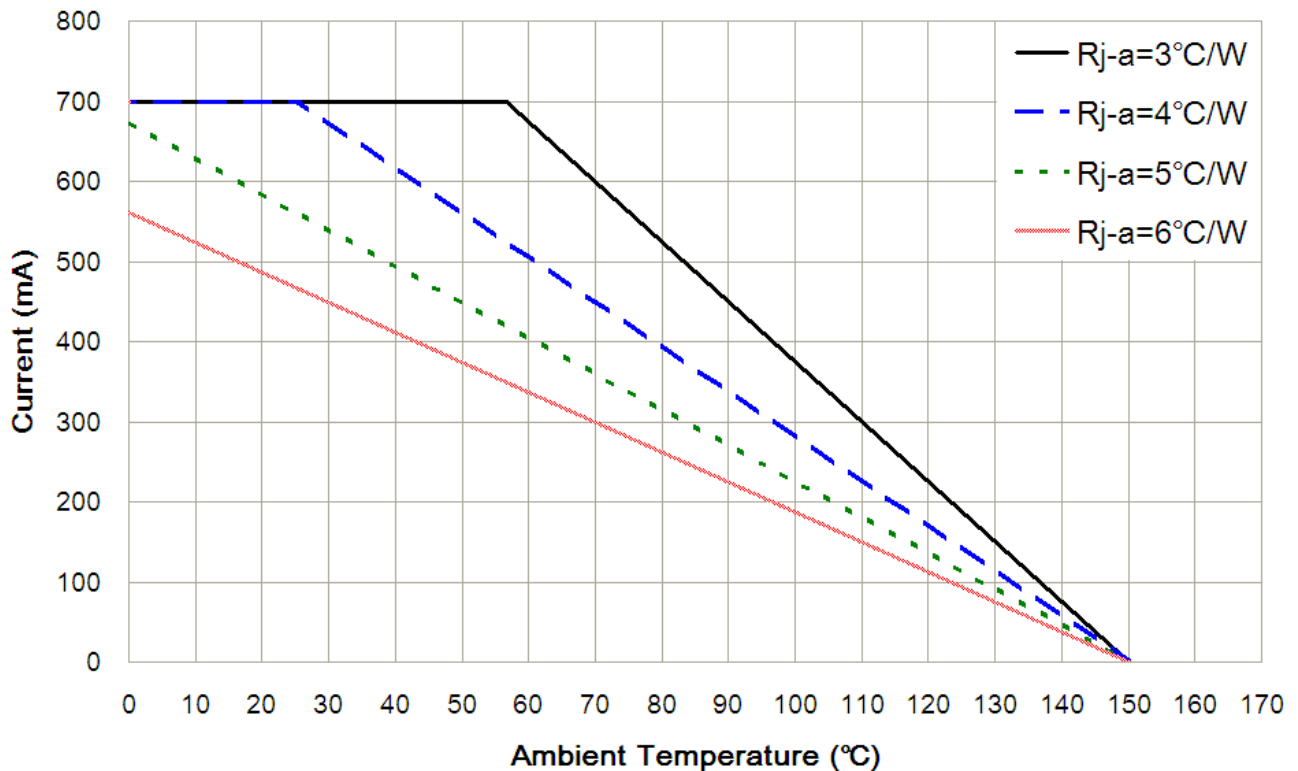

The junction temperature can be correlated to the thermal resistance between the junction and ambient ( $R_{ja}$ ) by the following equation.

$$T_j = T_a + R_{ja} * W$$

$T_j$ : LED junction temperature

$T_a$ : Ambient temperature

$R_{ja}$ : Thermal resistance between the junction and ambient

$W$ : Input power ( $I_f * V_f$ )

## Package Information

Dimensions. (Unit: mm)

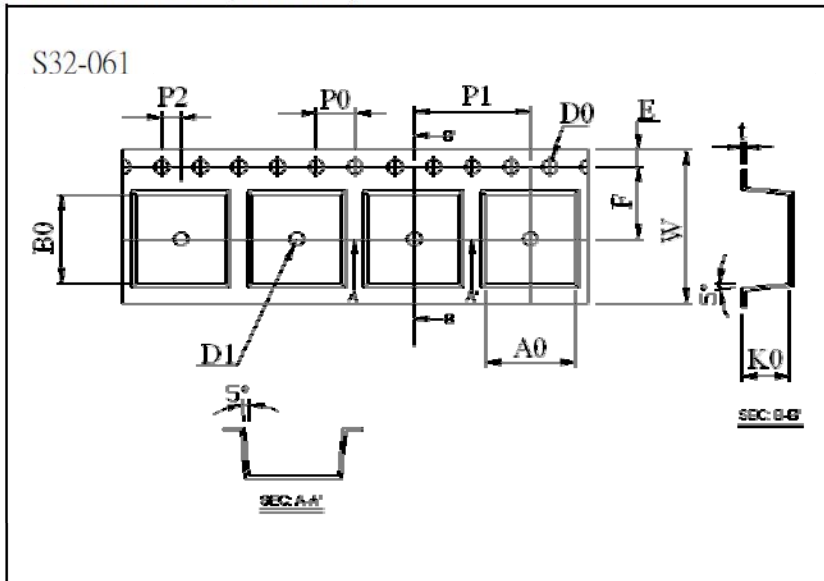

Item	Specification	Tol. (+/-)
W	16.00	± 0.30
E	1.75	± 0.10
F	7.50	± 0.10
D0	1.50	+0.10,-0
D1	1.50	+0.25,-0
P0	4.00	± 0.10
P1	12.00	± 0.10
P2	2.00	± 0.10
P0 x 10	40.00	± 0.20

t	0.35	± 0.05
A0	9.40	± 0.10
B0	9.40	± 0.10
K0	4.95	± 0.10

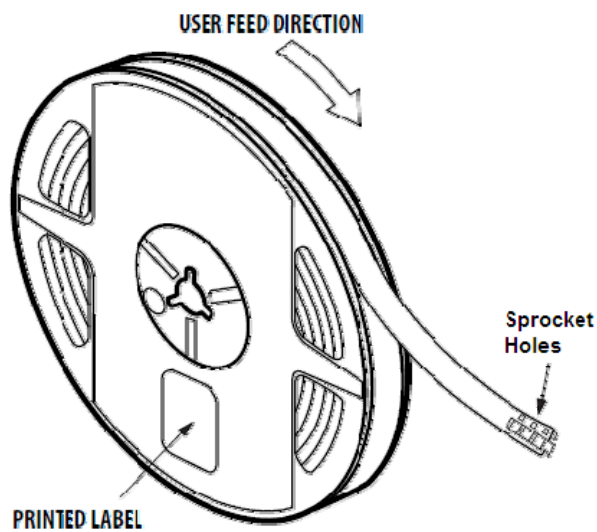
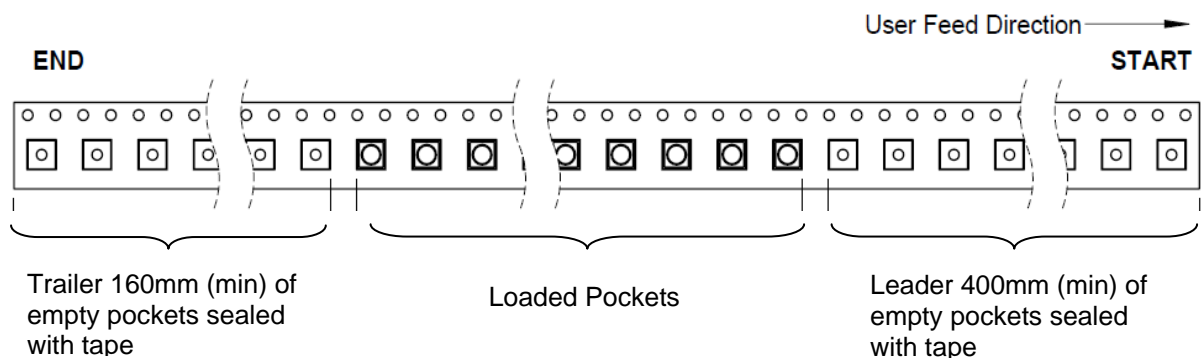

## About Us

SemiLEDs is an innovative manufacturer of chip-level and packaged LEDs that enable today's advanced solid state lighting solutions. Fully ISO9001 certified, with state of the art fabrication facilities in Hsinchu Science Park, Taiwan, the company employs patented and proprietary technologies that deliver high performance with increased color stability and lumen maintenance. SemiLEDs visible- and ultraviolet-LEDs are found in a wide variety of general lighting applications, including street lights and commercial, industrial and residential architectural lighting, along with specialty industrial applications such as UV curing, medical/cosmetic, counterfeit detection, and horticulture.

SemiLEDs is a publicly traded company on NASDAQ Global Select Market (stock symbol "LEDS"). For investor information, please contact us at [investors@semileds.com](mailto:investors@semileds.com).

For further company or product information, please visit us at [www.semileds.com](http://www.semileds.com) or please contact [sales@semileds.com](mailto:sales@semileds.com).



[www.semileds.com](http://www.semileds.com)

### ASIA PACIFIC

3F, No. 11, KeJung Rd.

Chu-Nan Site

Hsinchu Science Park

Chu-Nan 350, Miao-Li County

Taiwan, ROC

Tel: +886-37-586788

Fax: +886-37-582688

[sales@semileds.com](mailto:sales@semileds.com)